

900MHz Low Distortion, Low Noise Differential Amplifier/ADC Driver ($A_V = 4V/V$)

FEATURES

- 900MHz -3dB Bandwidth
- Fixed Gain of $4V/V$ (12dB)
- Low Distortion:
 - 40dBm OIP3, -73dBc HD3 (70MHz $2V_{P-P}$)
 - 51dBm OIP3, -94dBc HD3 (10MHz $2V_{P-P}$)
- Low Noise: 14.5dB NF, $e_n = 2.35\text{nV}/\sqrt{\text{Hz}}$ (70MHz)
- Differential Inputs and Outputs
- Additional Filtered Outputs
- Adjustable Output Common Mode Voltage
- DC- or AC-Coupled Operation
- Minimal Support Circuitry Required
- Small 0.75mm Tall 16-Lead 3×3 QFN Package

APPLICATIONS

- Differential ADC Driver for:
 - Imaging
 - Communications
- Differential Driver/Receiver
- Single Ended to Differential Conversion
- Differential to Single Ended Conversion
- Level Shifting
- IF Sampling Receivers
- SAW Filter Interfacing/Buffering

LT, LTC and LT are registered trademarks of Linear Technology Corporation. All other trademarks are the property of their respective owners.

DESCRIPTION

The LT[®]1993-4 is a low distortion, low noise Differential Amplifier/ADC driver for use in applications from DC to 900MHz. The LT1993-4 has been designed for ease of use, with minimal support circuitry required. Exceptionally low input-referred noise and low distortion products (with either single-ended or differential inputs) make the LT1993-4 an excellent solution for driving high speed 12-bit and 14-bit ADCs. In addition to the normal unfiltered outputs (+OUT and -OUT), the LT1993-4 has a built-in 175MHz differential lowpass filter and an additional pair of filtered outputs (+OUTFILTERED, -OUTFILTERED) to reduce external filtering components when driving high speed ADCs. The output common mode voltage is easily set via the V_{OCM} pin, eliminating either an output transformer or AC-coupling capacitors in many applications.

The LT1993-4 is designed to meet the demanding requirements of communications transceiver applications. It can be used as a differential ADC driver, a general-purpose differential gain block, or in any other application requiring differential drive. The LT1993-4 can be used in data acquisition systems required to function at frequencies down to DC.

The LT1993-4 operates on a 5V supply and consumes 100mA. It comes in a compact 16-lead 3×3 QFN package and operates over a -40°C to 85°C temperature range.

TYPICAL APPLICATION

ADC Driver with Single-Ended to Differential Conversion

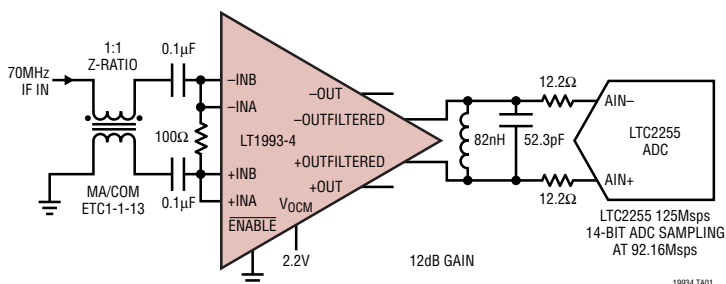

4-Tone WCDMA Waveform, LT1993-4 Driving LTC2255 14-Bit ADC at 92.16MSPS

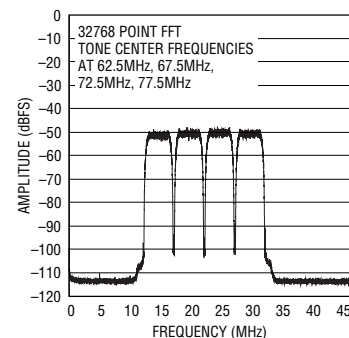

LT19934 TA02

19934fa

ABSOLUTE MAXIMUM RATINGS

(Note 1)

Total Supply Voltage ($V_{CCA}/V_{CCB}/V_{CCC}$ to $V_{EEA}/V_{EEB}/V_{EEC}$)5.5V

Input Current (+INA, -INA, +INB, -INB, V_{OCM} , \overline{ENABLE})±10mA

Output Current (Continuous) (Note 6)

+OUT, -OUT (DC)±100mA

(AC)±100mA

+OUTFILTERED, -OUTFILTERED (DC)±15mA

(AC)±45mA

Output Short Circuit Duration (Note 2) Indefinite

Operating Temperature Range (Note 3) ... -40°C to 85°C

Specified Temperature Range (Note 4) -40°C to 85°C

Storage Temperature Range..... -65°C to 125°C

Junction Temperature 125°C

Lead Temperature Range (Soldering 10 sec) 300°C

PACKAGE/ORDER INFORMATION

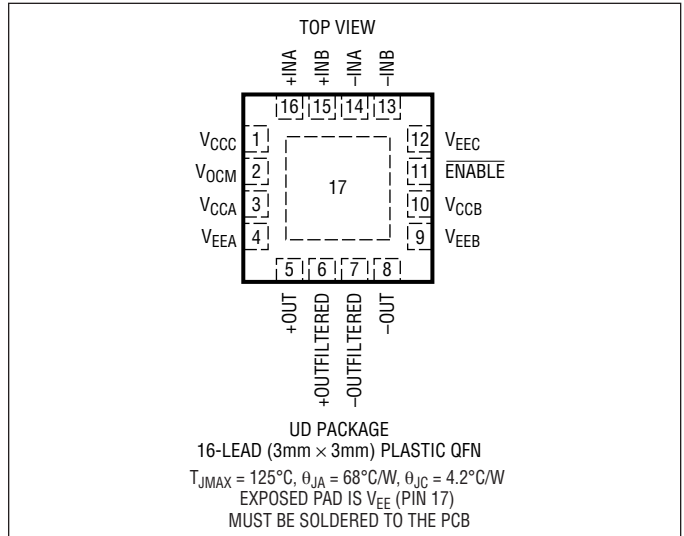

ORDER PART NUMBER	UD PART MARKING*
LT1993CUD-4	LBNS
LT1993IUD-4	LBNS

Order Options Tape and Reel: Add #TR
Lead Free: Add #PBF Lead Free Tape and Reel: Add #TRPBF
Lead Free Part Marking: <http://www.linear.com/leadfree/>

Consult LTC Marketing for parts specified with wider operating temperature ranges.
*The temperature grade is identified by a label on the shipping container.

DC ELECTRICAL CHARACTERISTICS

The ● denotes the specifications which apply over the full operating temperature range, otherwise specifications are at $T_A = 25^{\circ}\text{C}$. $V_{CCA} = V_{CCB} = V_{CCC} = 5\text{V}$, $V_{EEA} = V_{EEB} = V_{EEC} = 0\text{V}$, $\overline{ENABLE} = 0.8\text{V}$, +INA shorted to +INB (+IN), -INA shorted to -INB (-IN), $V_{OCM} = 2.2\text{V}$, Input common mode voltage = 2.2V, no R_{LOAD} unless otherwise noted.

SYMBOL	PARAMETER	CONDITIONS	MIN	TYP	MAX	UNITS
Input/Output Characteristics (+INA, +INB, -INA, -INB, +OUT, -OUT, +OUTFILTERED, -OUTFILTERED)						
GD _{DIFF}	Gain	Differential (+OUT, -OUT), $V_{IN} = \pm 0.4\text{V}$ Differential	● 11.6	11.9	12.4	dB
$V_{SWINGMIN}$		Single-Ended +OUT, -OUT, +OUTFILTERED, -OUTFILTERED. $V_{IN} = \pm 1.2\text{V}$ Differential	●	0.25	0.35 0.5	V V
$V_{SWINGMAX}$		Single-Ended +OUT, -OUT, +OUTFILTERED, -OUTFILTERED. $V_{IN} = \pm 1.2\text{V}$ Differential	●	3.6 3.5	3.75	V V
$V_{SWINGDIFF}$	Output Voltage Swing	Differential (+OUT, -OUT), $V_{IN} = \pm 1.2\text{V}_{P-P}$ Differential	●	6.5 6	7	V_{P-P} V_{P-P}
I_{OUT}	Output Current Drive	(Note 5)	●	±40	±45	mA
V_{OS}	Input Offset Voltage		●	-6.5 -10	1 10	mV mV
TCV_{OS}	Input Offset Voltage Drift	T_{MIN} to T_{MAX}	●	2.5		$\mu\text{V}/^{\circ}\text{C}$
I_{VRMIN}	Input Voltage Range, MIN	Single-Ended	●		0.5	V
I_{VRMAX}	Input Voltage Range, MAX	Single-Ended	●	4.3		V
R_{INDIFF}	Differential Input Resistance		●	77	100 122	Ω
C_{INDIFF}	Differential Input Capacitance			1		pF

DC ELECTRICAL CHARACTERISTICS The ● denotes the specifications which apply over the full operating temperature range, otherwise specifications are at $T_A = 25^\circ\text{C}$. $V_{CCA} = V_{CCB} = V_{CCC} = 5\text{V}$, $V_{EEA} = V_{EEB} = V_{EEC} = 0\text{V}$, $\text{ENABLE} = 0.8\text{V}$, $+INA$ shorted to $+INB$ (+IN), $-INA$ shorted to $-INB$ (-IN), $V_{OCM} = 2.2\text{V}$, Input common mode voltage = 2.2V, no R_{LOAD} unless otherwise noted.

SYMBOL	PARAMETER	CONDITIONS	MIN	TYP	MAX	UNITS
CMRR	Common Mode Rejection Ratio	Input Common Mode 0.5V to 4.3V	● 45	70		dB
$R_{OUTDIFF}$	Output Resistance			0.3		Ω
$C_{OUTDIFF}$	Output Capacitance			0.8		pF

Common Mode Voltage Control (V_{OCM} Pin)

GCM	Common Mode Gain	Differential (+OUT, -OUT), $V_{OCM} = 1.2\text{V to }3.6\text{V}$ Differential (+OUT, -OUT), $V_{OCM} = 1.4\text{V to }3.4\text{V}$	● 0.9	1	1.1	V/V	
V_{OCMMIN}	Output Common Mode Voltage Adjustment Range, MIN	Measured Single-Ended at +OUT and -OUT	●		1.2 1.4	V V	
V_{OCMMAX}	Output Common Mode Voltage Adjustment Range, MAX	Measured Single-Ended at +OUT and -OUT	●	3.6 3.4		V V	
V_{OSCM}	Output Common Mode Offset Voltage	Measured from V_{OCM} to Average of +OUT and -OUT	●	-30	2	30	mV
I_{BIASCM}	V_{OCM} Input Bias Current		●	5	15	μA	
R_{INCM}	V_{OCM} Input Resistance		● 0.8	3		M Ω	
C_{INCM}	V_{OCM} Input Capacitance			1		pF	

ENABLE Pin

V_{IL}	ENABLE Input Low Voltage		●		0.8	V
V_{IH}	ENABLE Input High Voltage		●	2		V
I_{IL}	ENABLE Input Low Current	ENABLE = 0.8V	●		0.5	μA
I_{IH}	ENABLE Input High Current	ENABLE = 2V	●	1	3	μA

Power Supply

V_S	Operating Range		●	4	5	5.5	V
I_S	Supply Current	ENABLE = 0.8V	●	88	100	112	mA
$I_{SDISABLED}$	Supply Current (Disabled)	ENABLE = 2V	●		250	500	μA
PSRR	Power Supply Rejection Ratio	4V to 5.5V	●	55	90		dB

AC ELECTRICAL CHARACTERISTICS $T_A = 25^\circ\text{C}$, $V_{CCA} = V_{CCB} = V_{CCC} = 5\text{V}$, $V_{EEA} = V_{EEB} = V_{EEC} = 0\text{V}$, $\text{ENABLE} = 0.8\text{V}$, $+INA$ shorted to $+INB$ (+IN), $-INA$ shorted to $-INB$ (-IN), $V_{OCM} = 2.2\text{V}$, Input common mode voltage = 2.2V, no R_{LOAD} unless otherwise noted.

SYMBOL	PARAMETER	CONDITIONS	MIN	TYP	MAX	UNITS
Input/Output Characteristics						
-3dBBW	-3dB Bandwidth	200mV _{p-p} Differential (+OUT, -OUT)	500	900		MHz
0.1dBBW	Bandwidth for 0.1dB Flatness	200mV _{p-p} Differential (+OUT, -OUT)		50		MHz
0.5dBBW	Bandwidth for 0.5dB Flatness	200mV _{p-p} Differential (+OUT, -OUT)		100		MHz
SR	Slew Rate	3.2V _{p-p} Differential (+OUT, -OUT)		1100		V/ μs
$t_{s1\%}$	1% Settling Time	1% Settling for a 1V _{p-p} Differential Step (+OUT, -OUT)		4		ns
t_{ON}	Turn-On Time			40		ns
t_{OFF}	Turn-Off Time			250		ns

AC ELECTRICAL CHARACTERISTICS $T_A = 25^\circ\text{C}$, $V_{CCA} = V_{CCB} = V_{CCC} = 5\text{V}$, $V_{EEA} = V_{EEB} = V_{EEC} = 0\text{V}$, $\text{ENABLE} = 0.8\text{V}$, +INA shorted to +INB (+IN), -INA shorted to -INB (-IN), $V_{OCM} = 2.2\text{V}$, Input common mode voltage = 2.2V, no R_{LOAD} unless otherwise noted.

SYMBOL	PARAMETER	CONDITIONS	MIN	TYP	MAX	UNITS
Common Mode Voltage Control (V_{OCM} Pin)						
-3dB BW_{CM}	Common Mode Small-Signal -3dB Bandwidth	0.1V $_{P-P}$ at V_{OCM} , Measured Single-Ended at +OUT and -OUT		300		MHz
SRCM	Common Mode Slew Rate	1.2V to 3.6V Step at V_{OCM}		500		V/ μs
Noise/Harmonic Performance Input/output Characteristics						
1kHz Signal						
	Second/Third Harmonic Distortion	2V $_{P-P}$ Differential (+OUTFILTERED, -OUTFILTERED)		-100		dBc
		2V $_{P-P}$ Differential (+OUT, -OUT)		-100		dBc
		2V $_{P-P}$ Differential (+OUT, -OUT), $R_L = 100\Omega$		-100		dBc
		3.2V $_{P-P}$ Differential (+OUTFILTERED, -OUTFILTERED)		-91		dBc
		3.2V $_{P-P}$ Differential (+OUT, -OUT)		-91		dBc
		3.2V $_{P-P}$ Differential (+OUT, -OUT), $R_L = 100\Omega$		-91		dBc
	Third-Order IMD	2V $_{P-P}$ Differential Composite (+OUTFILTERED, -OUTFILTERED), $f_1 = 0.95\text{kHz}$, $f_2 = 1.05\text{kHz}$		-102		dBc
		2V $_{P-P}$ Differential Composite (+OUT, -OUT), $R_L = 100\Omega$, $f_1 = 0.95\text{kHz}$, $f_2 = 1.05\text{kHz}$		-102		dBc
		3.2V $_{P-P}$ Differential Composite (+OUTFILTERED, -OUTFILTERED), $f_1 = 0.95\text{kHz}$, $f_2 = 1.05\text{kHz}$		-93		dBc
OIP $_{31k}$	Output Third-Order Intercept	Differential (+OUTFILTERED, -OUTFILTERED), $f_1 = 0.95\text{kHz}$, $f_2 = 1.05\text{kHz}$		54		dBm
e_{n1k}	Input Referred Noise Voltage Density			2.15		nV/ $\sqrt{\text{Hz}}$
	1dB Compression Point			22.7		dBm
10MHz Signal						
	Second/Third Harmonic Distortion	2V $_{P-P}$ Differential (+OUTFILTERED, -OUTFILTERED)		-94		dBc
		2V $_{P-P}$ Differential (+OUT, -OUT)		-94		dBc
		2V $_{P-P}$ Differential (+OUT, -OUT), $R_L = 100\Omega$		-86		dBc
		3.2V $_{P-P}$ Differential (+OUTFILTERED, -OUTFILTERED)		-85		dBc
		3.2V $_{P-P}$ Differential (+OUT, -OUT)		-85		dBc
		3.2V $_{P-P}$ Differential (+OUT, -OUT), $R_L = 100\Omega$		-77		dBc
	Third-Order IMD	2V $_{P-P}$ Differential Composite (+OUTFILTERED, -OUTFILTERED), $f_1 = 9.5\text{MHz}$, $f_2 = 10.5\text{MHz}$		-96		dBc
		2V $_{P-P}$ Differential Composite (+OUT, -OUT), $R_L = 100\Omega$, $f_1 = 9.5\text{MHz}$, $f_2 = 10.5\text{MHz}$		-96		dBc
		3.2V $_{P-P}$ Differential Composite (+OUTFILTERED, -OUTFILTERED), $f_1 = 9.5\text{MHz}$, $f_2 = 10.5\text{MHz}$		-87		dBc
OIP $_{310M}$	Output Third-Order Intercept	Differential (+OUTFILTERED, -OUTFILTERED), $f_1 = 9.5\text{MHz}$, $f_2 = 10.5\text{MHz}$		51		dBm
NF	Noise Figure	Measured Using DC800A Demo Board		13.7		dB
e_{n10M}	Input Referred Noise Voltage Density			2.15		nV/ $\sqrt{\text{Hz}}$
	1dB Compression Point			22.6		dBm
50MHz Signal						
	Second/Third Harmonic Distortion	2V $_{P-P}$ Differential (+OUTFILTERED, -OUTFILTERED)		-80		dBc
		2V $_{P-P}$ Differential (+OUT, -OUT)		-78		dBc
		2V $_{P-P}$ Differential (+OUT, -OUT), $R_L = 100\Omega$		-75		dBc

AC ELECTRICAL CHARACTERISTICS $T_A = 25^\circ\text{C}$, $V_{CCA} = V_{CCB} = V_{CCC} = 5\text{V}$, $V_{EEA} = V_{EEB} = V_{EEC} = 0\text{V}$, $\text{ENABLE} = 0.8\text{V}$, $+INA$ shorted to $+INB$ ($+IN$), $-INA$ shorted to $-INB$ ($-IN$), $V_{OCM} = 2.2\text{V}$, Input common mode voltage = 2.2V , no R_{LOAD} unless otherwise noted.

SYMBOL	PARAMETER	CONDITIONS	MIN	TYP	MAX	UNITS
		3.2V _{p-p} Differential (+OUTFILTERED, -OUTFILTERED)		-71		dBc
		3.2V _{p-p} Differential (+OUT, -OUT)		-69		dBc
		3.2V _{p-p} Differential (+OUT, -OUT), $R_L = 100\Omega$		-66		dBc
	Third-Order IMD	2V _{p-p} Differential Composite (+OUTFILTERED, -OUTFILTERED), $f_1 = 49.5\text{MHz}$, $f_2 = 50.5\text{MHz}$		-81		dBc
		2V _{p-p} Differential Composite (+OUT, -OUT), $R_L = 100\Omega$, $f_1 = 49.5\text{MHz}$, $f_2 = 50.5\text{MHz}$		-80		dBc
		3.2V _{p-p} Differential Composite (+OUTFILTERED, -OUTFILTERED), $f_1 = 49.5\text{MHz}$, $f_2 = 50.5\text{MHz}$		-72		dBc
OIP _{350M}	Output Third-Order Intercept	Differential (+OUTFILTERED, -OUTFILTERED), $f_1 = 49.5\text{MHz}$, $f_2 = 50.5\text{MHz}$		43		dBm
NF	Noise Figure	Measured Using DC800A Demo Board		14.1		dB
e_{n50M}	Input Referred Noise Voltage Density			2.25		nV/ $\sqrt{\text{Hz}}$
	1dB Compression Point			19.7		dBm
70MHz Signal						
	Second/Third Harmonic Distortion	2V _{p-p} Differential (+OUTFILTERED, -OUTFILTERED)		-73		dBc
		2V _{p-p} Differential (+OUT, -OUT)		-71		dBc
		2V _{p-p} Differential (+OUT, -OUT), $R_L = 100\Omega$		-70		dBc
	Third-Order IMD	2V _{p-p} Differential Composite (+OUTFILTERED, -OUTFILTERED), $f_1 = 69.5\text{MHz}$, $f_2 = 70.5\text{MHz}$		-74		dBc
		2V _{p-p} Differential Composite (+OUT, -OUT), $R_L = 100\Omega$, $f_1 = 69.5\text{MHz}$, $f_2 = 70.5\text{MHz}$		-71		dBc
OIP _{370M}	Output Third-Order Intercept	Differential (+OUTFILTERED, -OUTFILTERED), $f_1 = 69.5\text{MHz}$, $f_2 = 70.5\text{MHz}$		40		dBm
NF	Noise Figure	Measured Using DC800A Demo Board		14.5		dB
e_{n70M}	Input Referred Noise Voltage Density			2.35		nV/ $\sqrt{\text{Hz}}$
	1dB Compression Point			18.5		dBm
100MHz Signal						
	Second/Third Harmonic Distortion	2V _{p-p} Differential (+OUTFILTERED, -OUTFILTERED)		-61		dBc
		2V _{p-p} Differential (+OUT, -OUT)		-63		dBc
		2V _{p-p} Differential (+OUT, -OUT), $R_L = 100\Omega$		-62		dBc
	Third-Order IMD	2V _{p-p} Differential Composite (+OUTFILTERED, -OUTFILTERED), $f_1 = 99.5\text{MHz}$, $f_2 = 100.5\text{MHz}$		-61		dBc
		2V _{p-p} Differential Composite (+OUT, -OUT), $R_L = 100\Omega$, $f_1 = 99.5\text{MHz}$, $f_2 = 100.5\text{MHz}$		-63		dBc
OIP _{3100M}	Output Third-Order Intercept	Differential (+OUTFILTERED, -OUTFILTERED), $f_1 = 99.5\text{MHz}$, $f_2 = 100.5\text{MHz}$		33.5		dBm
NF	Noise Figure	Measured Using DC800A Demo Board		15.1		dB
e_{n100M}	Input Referred Noise Voltage Density			2.55		nV/ $\sqrt{\text{Hz}}$
	1dB Compression Point			17.8		dBm

Note 1: Absolute Maximum Ratings are those values beyond which the life of a device may be impaired.

Note 2: As long as output current and junction temperature are kept below the Absolute Maximum Ratings, no damage to the part will occur.

Note 3: The LT1993C-4 is guaranteed functional over the operating temperature range of -40°C to 85°C .

Note 4: The LT1993C-4 is guaranteed to meet specified performance from 0°C to 70°C . It is designed, characterized and expected to meet specified performance from -40°C and 85°C but is not tested or QA sampled at these temperatures. The LT1993I-4 is guaranteed to meet specified performance from -40°C to 85°C .

Note 5: This parameter is pulse tested.

Note 6: This parameter is guaranteed to meet specified performance through design and characterization. It has not been tested.

TYPICAL PERFORMANCE CHARACTERISTICS

Frequency Response
 $R_{LOAD} = 400\Omega$

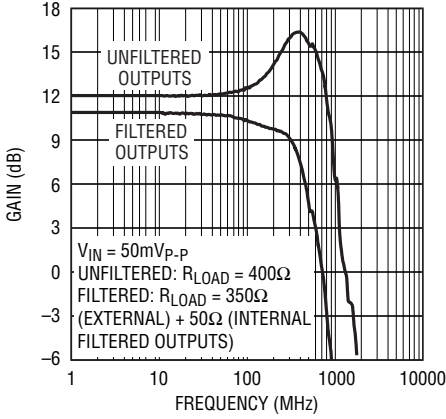

19934 G01

Frequency Response vs C_{LOAD}
 $R_{LOAD} = 400\Omega$

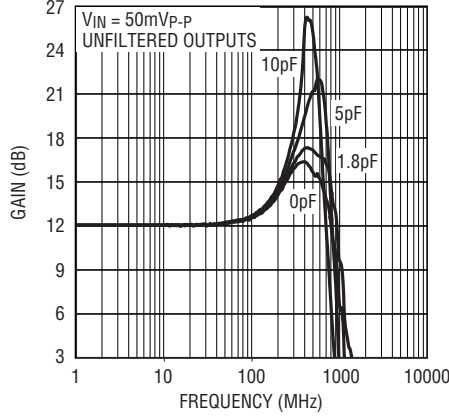

19934 G02

Frequency Response
 $R_{LOAD} = 100\Omega$

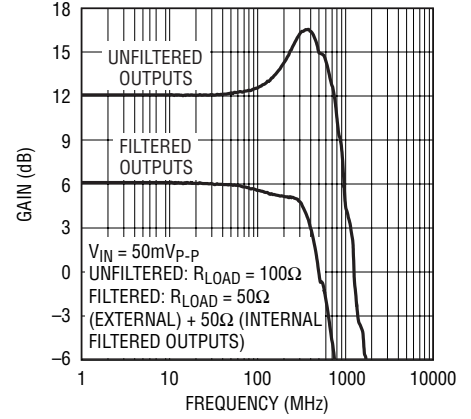

19934 G03

Third Order Intermodulation Distortion vs Frequency
Differential Input, No R_{LOAD}

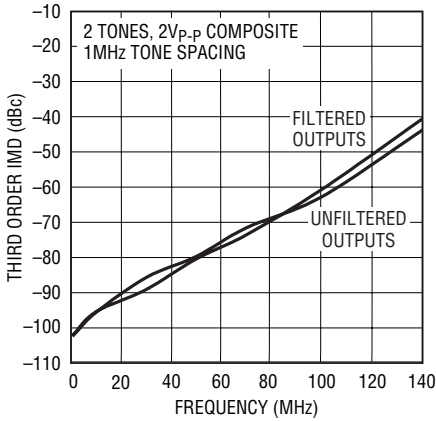

19934 G04

Third Order Intermodulation Distortion vs Frequency
Differential Input, $R_{LOAD} = 400\Omega$

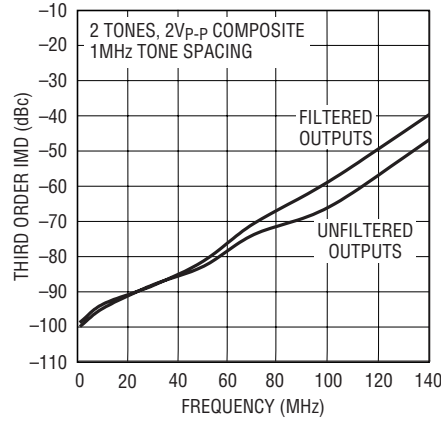

19934 G05

Third Order Intermodulation Distortion vs Frequency
Differential Input, $R_{LOAD} = 100\Omega$

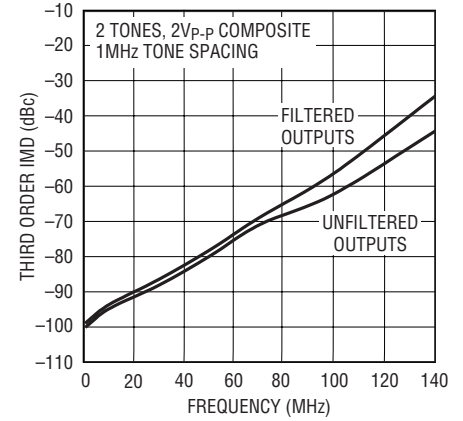

19934 G06

Output Third Order Intercept vs Frequency, Differential Input
No R_{LOAD}

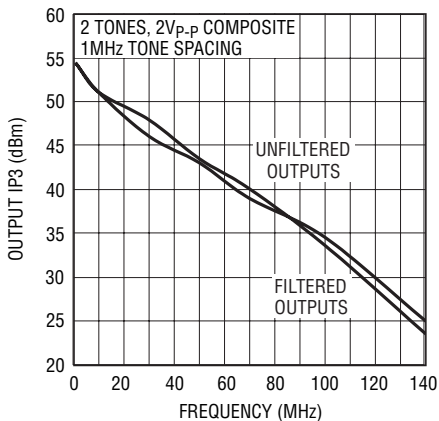

19334 G07

Output Third Order Intercept vs Frequency, Differential Input
 $R_{LOAD} = 400\Omega$

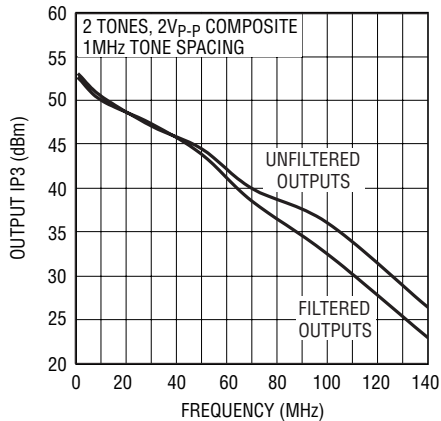

19334 G08

Output Third Order Intercept vs Frequency, Differential Input
 $R_{LOAD} = 100\Omega$

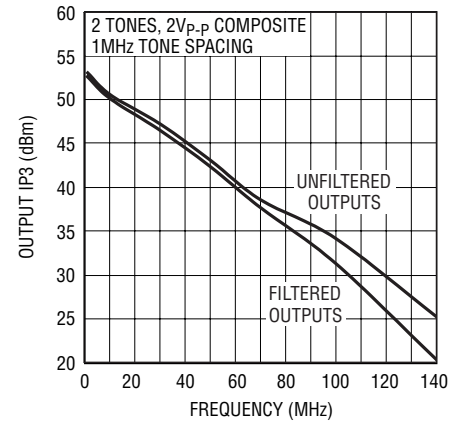

19934 G09

19934fa

TYPICAL PERFORMANCE CHARACTERISTICS

Distortion (Filtered) vs Frequency
Differential Input, No R_{LOAD}

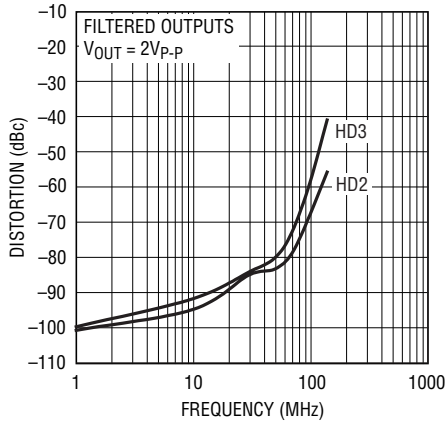

19934 G10

Distortion (Unfiltered) vs Frequency, Differential Input, No R_{LOAD}

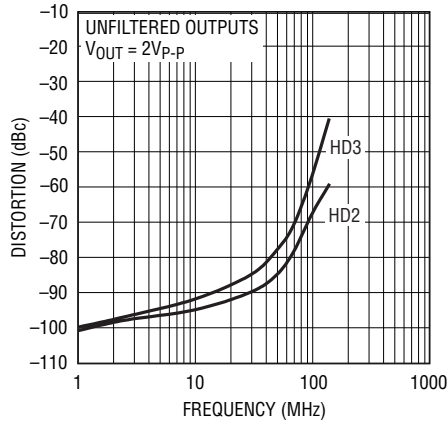

19934 G11

Distortion vs Output Amplitude
70MHz Differential Input
No R_{LOAD}

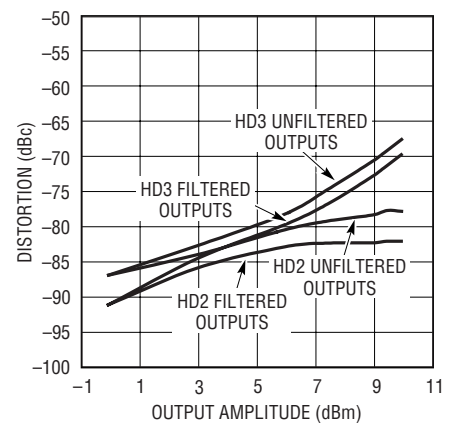

19934 G12

Output 1dB Compression vs Frequency

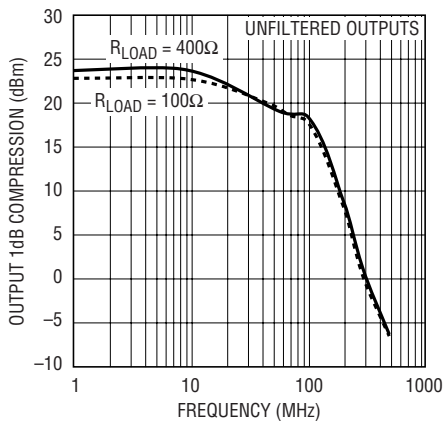

19934 G13

Noise Figure vs Frequency

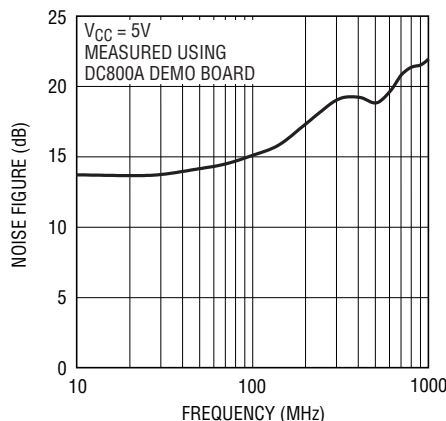

19934 G14

Input Referred Noise Voltage vs Frequency

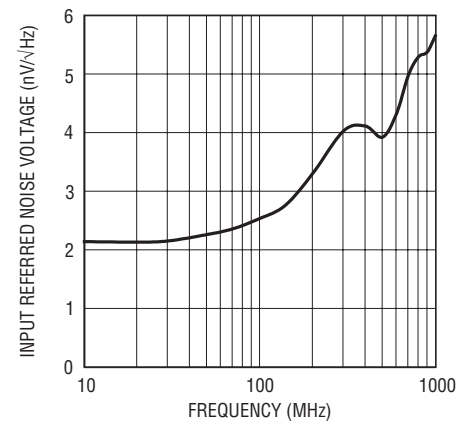

19934 G15

Reverse Isolation vs Frequency

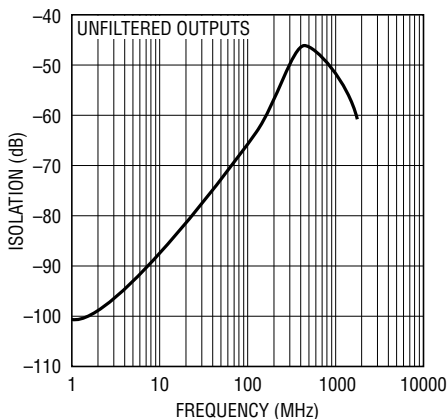

19934 G16

Differential Input Impedance vs Frequency

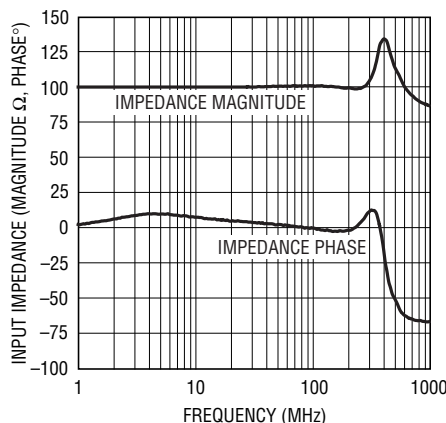

19934 G17

Differential Output Impedance vs Frequency

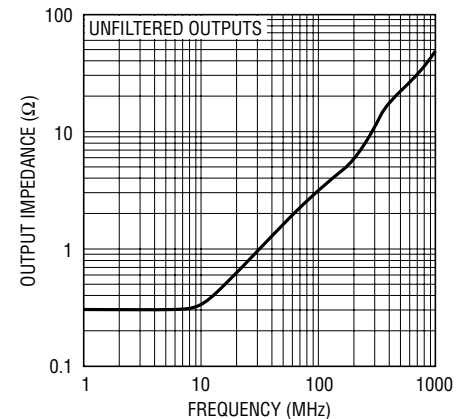

19934 G18

19934fa

TYPICAL PERFORMANCE CHARACTERISTICS

Input Reflection Coefficient vs Frequency

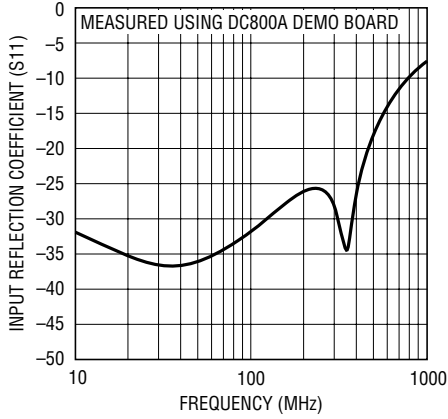

19934 G19

Output Reflection Coefficient vs Frequency

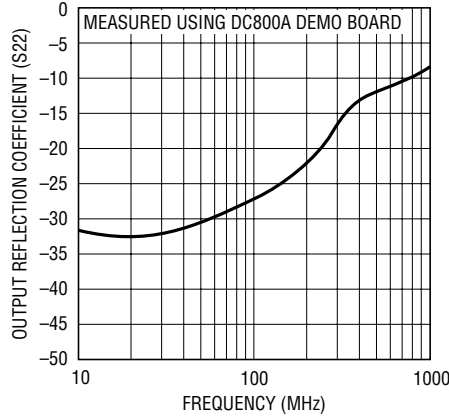

19934 G20

PSRR, CMRR vs Frequency

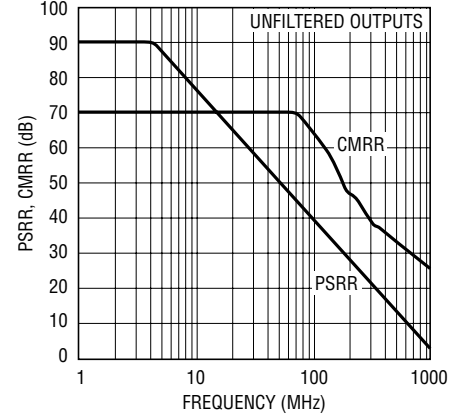

19934 G21

Small-Signal Transient Response

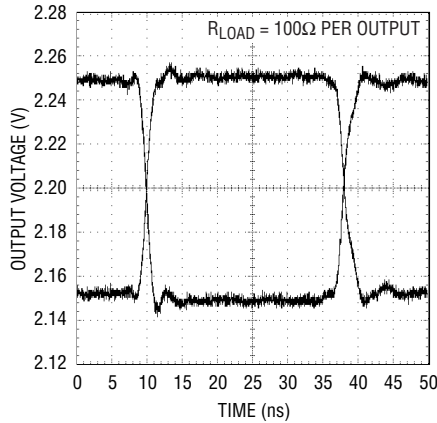

19934 G22

Large-Signal Transient Response

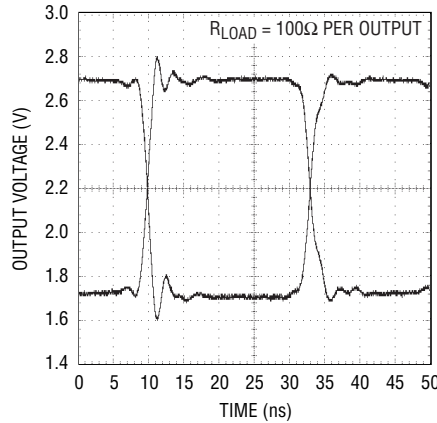

19934 G23

Overdrive Recovery Time

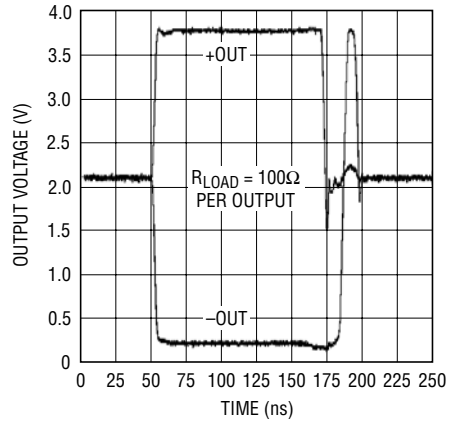

19934 G24

Distortion vs Output Common Mode Voltage, LT1993-4 Driving LTC2249 14-Bit ADC

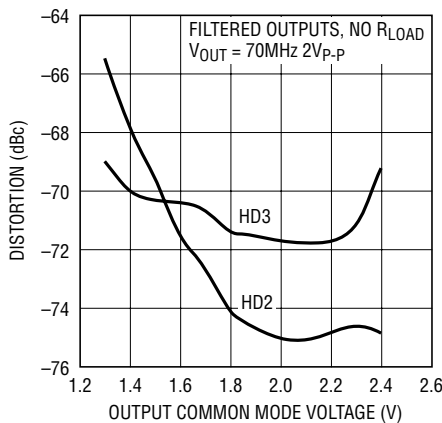

19934 G25

Turn-On Time

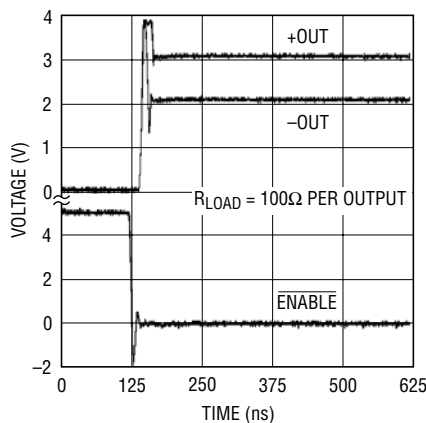

19934 G26

Turn-Off Time

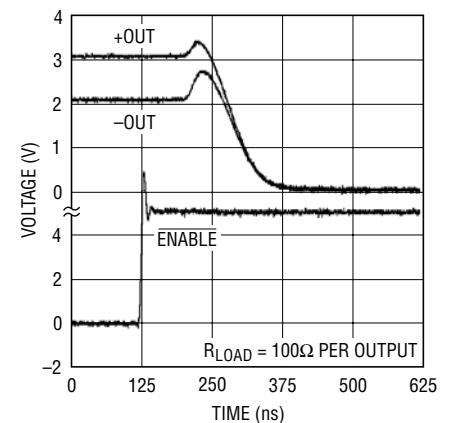

19934 G27

TYPICAL PERFORMANCE CHARACTERISTICS

30MHz 8192 Point FFT, LT1993-4 Driving LTC2249 14-Bit ADC

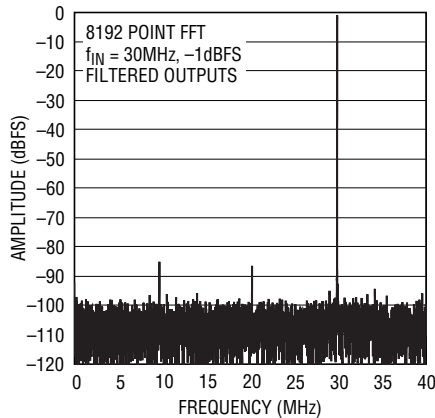

50MHz 8192 Point FFT, LT1993-4 Driving LTC2249 14-Bit ADC

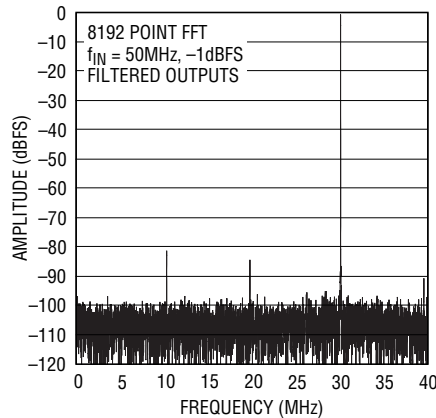

70MHz 8192 Point FFT, LT1993-4 Driving LTC2249 14-Bit ADC

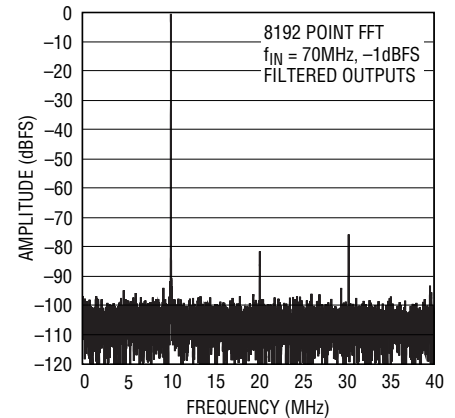

70MHz 2-Tone 32768 Point FFT LT1993-4 Driving LTC2249 14-Bit ADC

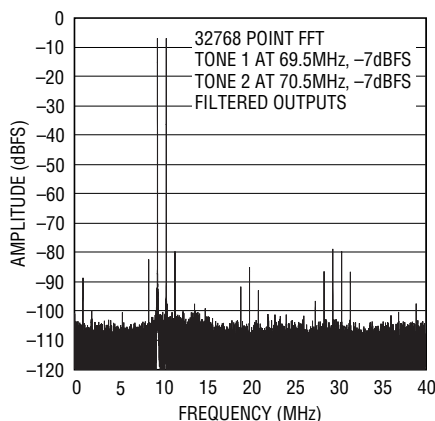

2-Tone WCDMA Waveform LT1993-4 Driving LTC2255 14-Bit ADC at 92.16Mps

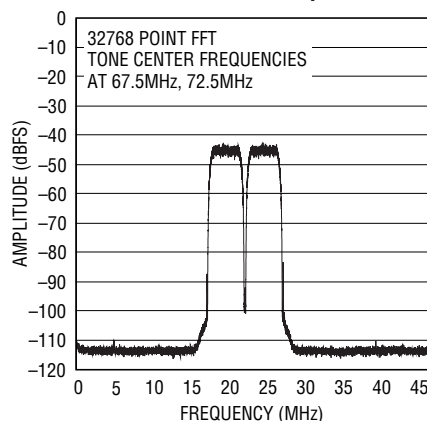

4-Tone WCDMA Waveform LT1993-4 Driving LTC2255 14-Bit ADC at 92.16Mps

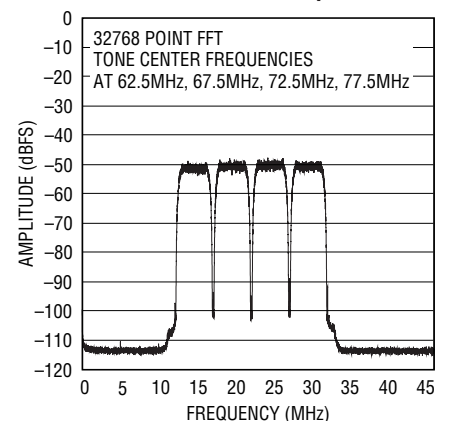

PIN FUNCTIONS

V_{OCM} (Pin 2): This pin sets the output common mode voltage. Without additional biasing, both inputs bias to this voltage as well. This input is high impedance.

V_{CCA} , V_{CCB} , V_{CCC} (Pins 3, 10, 1): Positive Power Supply (Normally Tied to 5V). All three pins must be tied to the same voltage. Bypass each pin with 1000pF and 0.1 μ F capacitors as close to the package as possible. Split supplies are possible as long as the voltage between V_{CC} and V_{EE} is 5V.

V_{EEA} , V_{EEB} , V_{EEC} (Pins 4, 9, 12): Negative Power Supply (Normally Tied to Ground). All three pins must be tied to the same voltage. Split supplies are possible as long as the voltage between V_{CC} and V_{EE} is 5V. If these pins are not tied to ground, bypass each pin with 1000pF and 0.1 μ F capacitors as close to the package as possible.

+OUT, -OUT (Pins 5, 8): Outputs (Unfiltered). These pins are high bandwidth, low-impedance outputs. The DC output voltage at these pins is set to the voltage applied at V_{OCM} .

PIN FUNCTIONS

+OUTFILTERED, -OUTFILTERED (Pins 6, 7): Filtered Outputs. These pins add a series 25Ω resistor from the unfiltered outputs and three 12pF capacitors. Each output has 12pF to V_{EE} , plus an additional 12pF between each pin (See the Block Diagram). This filter has a -3dB bandwidth of 175MHz .

ENABLE (Pin 11): This pin is a TTL logic input referenced to the V_{EEC} pin. If low, the LT1993-4 is enabled and draws typically 100mA of supply current. If high, the LT1993-4 is disabled and draws typically $250\mu\text{A}$.

-INA, -INB (Pins 14, 13): Negative Inputs. These pins are normally tied together. These inputs may be DC- or AC-coupled. If the inputs are AC-coupled, they will self-bias to the voltage applied to the V_{OCM} pin.

+INA, +INB (Pins 16, 15): Positive Inputs. These pins are normally tied together. These inputs may be DC- or AC-coupled. If the inputs are AC-coupled, they will self-bias to the voltage applied to the V_{OCM} pin.

Exposed Pad (Pin 17): Tie the pad to V_{EEC} (Pin 12). If split supplies are used, DO NOT tie the pad to ground.

BLOCK DIAGRAM

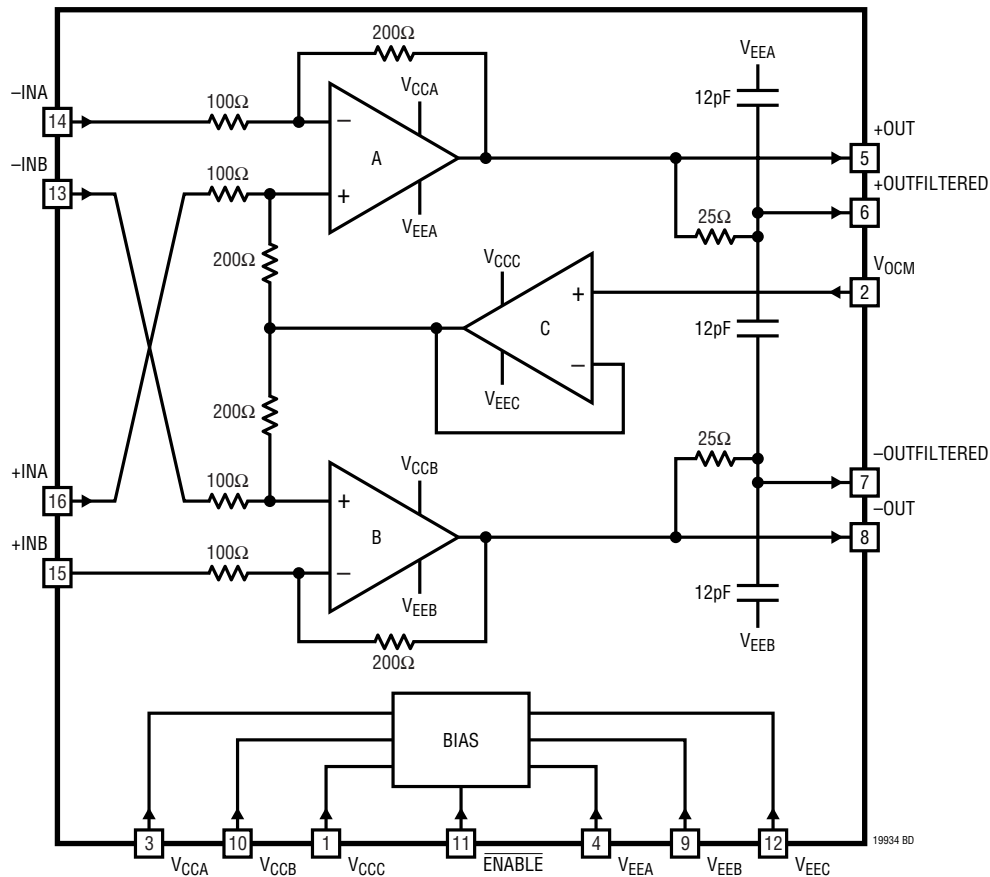

APPLICATIONS INFORMATION

Circuit Description

The LT1993-4 is a low noise, low distortion differential amplifier/ADC driver with:

- DC to 900MHz -3dB bandwidth
- Fixed gain of 4V/V (12dB) independent of R_{LOAD}
- 100Ω differential input impedance
- Low output impedance
- Built-in, user adjustable output filtering
- Requires minimal support circuitry

Referring to the block diagram, the LT1993-4 uses a closed-loop topology which incorporates 3 internal amplifiers. Two of the amplifiers (A and B) are identical and drive the differential outputs. The third amplifier (C) is used to set the output common mode voltage. Gain and input impedance are set by the $100\Omega/200\Omega$ resistors in the internal feedback network. Output impedance is low, determined by the inherent output impedance of amplifiers A and B, and further reduced by internal feedback.

The LT1993-4 also includes built-in single-pole output filtering. The user has the choice of using the unfiltered outputs, the filtered outputs (175MHz -3dB lowpass), or modifying the filtered outputs to alter frequency response by adding additional components. Many lowpass and bandpass filters are easily implemented with just one or two additional components.

The LT1993-4 has been designed to minimize the need for external support components such as transformers or AC-coupling capacitors. As an ADC driver, the LT1993-4 requires no external components except for power-supply bypass capacitors. This allows DC-coupled operation for applications that have frequency ranges including DC. At the outputs, the common mode voltage is set via the V_{OCM} pin, allowing the LT1993-4 to drive ADCs directly. No output AC-coupling capacitors or transformers are needed. At the inputs, signals can be differential or single-ended with virtually no difference in performance. Furthermore, DC levels at the inputs can be set independently of the output common mode voltage. These input characteristics often eliminate the need for an input transformer and/or AC-coupling capacitors.

Input Impedance and Matching Networks

Because of the internal feedback network, calculation of the LT1993-4's input impedance is not straightforward from examination of the block diagram. Furthermore, the input impedance when driven differentially is different than when driven single-ended. When driven differentially, the LT1993-4's input impedance is 100Ω (differential); when driven single-ended, the input impedance is 75Ω .

For single-ended 50Ω applications, a 150Ω shunt matching resistor to ground will result in the proper input termination (Figure 1). For differential inputs there are several termination options. If the input source is 50Ω differential, then input matching can be accomplished by either a 100Ω shunt resistor across the inputs (Figure 3), or a 49.9Ω shunt resistor on each of the inputs to ground (Figure 2).

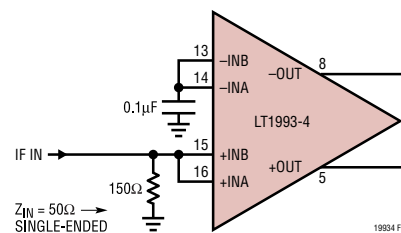

Figure 1. Input Termination for Single-Ended 50Ω Input Impedance

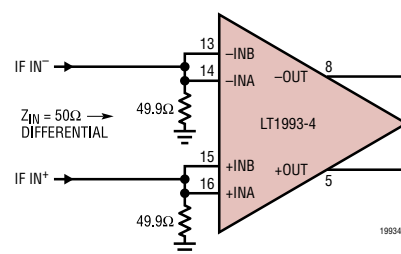

Figure 2. Input Termination for Differential 50Ω Input Impedance

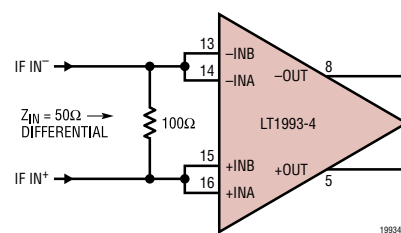

Figure 3. Alternate Input Termination for Differential 50Ω Input Impedance

APPLICATIONS INFORMATION

Single-Ended to Differential Operation

The LT1993-4's performance with single-ended inputs is comparable to its performance with differential inputs. This excellent single-ended performance is largely due to the internal topology of the LT1993-4. Referring to the block diagram, if the +INA and +INB pins are driven with a single-ended signal (while -INA and -INB are tied to AC ground), then the +OUT and -OUT pins are driven differentially without any voltage swing needed from amplifier C. Single-ended to differential conversion using more conventional topologies suffers from performance limitations due to the common mode amplifier.

Driving ADCs

The LT1993-4 has been specifically designed to interface directly with high speed Analog to Digital Converters (ADCs). In general, these ADCs have differential inputs, with an input impedance of 1k or higher. In addition, there is generally some form of lowpass or bandpass filtering just prior to the ADC to limit input noise at the ADC, thereby improving system signal to noise ratio. Both the unfiltered and filtered outputs of the LT1993-4 can easily drive the high impedance inputs of these differential ADCs. If the filtered outputs are used, then cutoff frequency and the type of filter can be tailored for the specific application if needed.

Wideband Applications (Using the +OUT and -OUT Pins)

In applications where the full bandwidth of the LT1993-4 is desired, the unfiltered output pins (+OUT and -OUT) should be used. They have a low output impedance; therefore, gain is unaffected by output load. Capacitance in excess of 5pF placed directly on the unfiltered outputs results in additional peaking and reduced performance. When driving an ADC directly, a small series resistance is recommended between the LT1993-4's outputs and the ADC inputs (Figure 4). This resistance helps eliminate any resonances associated with bond wire inductances of either the ADC inputs or the LT1993-4's outputs. A value between 10Ω and 25Ω gives excellent results.

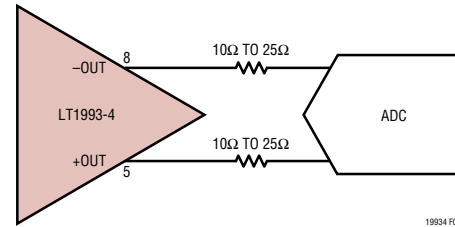

Figure 4. Adding Small Series R at LT1993-4 Output

Filtered Applications (Using the +OUTFILTERED and -OUTFILTERED Pins)

Filtering at the output of the LT1993-4 is often desired to provide either anti-aliasing or improved signal to noise ratio. To simplify this filtering, the LT1993-4 includes an additional pair of differential outputs (+OUTFILTERED and -OUTFILTERED) which incorporate an internal lowpass filter network with a -3dB bandwidth of 175MHz (Figure 5). These pins each have an output impedance of 25Ω. Internal capacitances are 12pF to V_{EE} on each filtered output, plus an additional 12pF capacitor connected differentially between the two filtered outputs. This resistor/capacitor combination creates filtered outputs that look like a series 25Ω resistor with a 36pF capacitor shunting each filtered output to AC ground, giving a -3dB bandwidth of 175MHz.

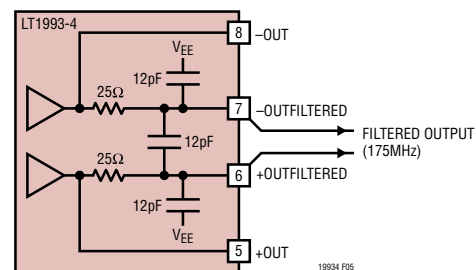

Figure 5. LT1993-4 Internal Filter Topology -3dB BW ≈175MHz

The filter cutoff frequency is easily modified with just a few external components. To increase the cutoff frequency, simply add 2 equal value resistors, one between +OUT and +OUTFILTERED and the other between -OUT and -OUTFILTERED (Figure 6). These resistors are in parallel with the internal 25Ω resistor, lowering the overall resistance and increasing filter bandwidth. To double the filter bandwidth, for example, add two external 25Ω resistors to lower the series resistance to 12.5Ω. The 36pF of capacitance remains unchanged, so filter bandwidth doubles.

APPLICATIONS INFORMATION

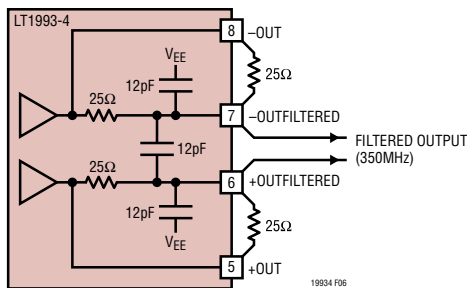

Figure 6. LT1993-4 Internal Filter Topology Modified for 2x Filter Bandwidth (2 External Resistors)

To decrease filter bandwidth, add two external capacitors, one from +OUTFILTERED to ground, and the other from -OUTFILTERED to ground. A single differential capacitor connected between +OUTFILTERED and -OUTFILTERED can also be used, but since it is being driven differentially it will appear at each filtered output as a single-ended capacitance of twice the value. To halve the filter bandwidth, for example, two 36pF capacitors could be added (one from each filtered output to ground). Alternatively one 18pF capacitor could be added between the filtered outputs, again halving the filter bandwidth. Combinations of capacitors could be used as well; a three capacitor solution of 12pF from each filtered output to ground plus a 12pF capacitor between the filtered outputs would also halve the filter bandwidth (Figure 7).

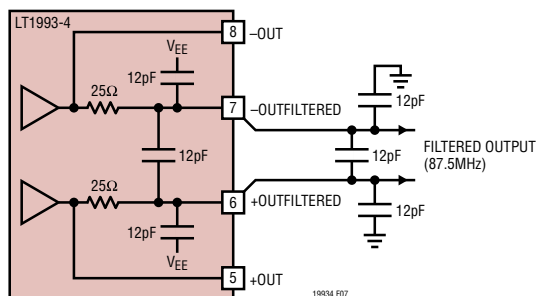

Figure 7. LT1993-4 Internal Filter Topology Modified for 1/2x Filter Bandwidth (3 External Capacitors)

Bandpass filtering is also easily implemented with just a few external components. An additional 120pF and 39nH, each added differentially between +OUTFILTERED and -OUTFILTERED creates a bandpass filter with a 71MHz center frequency, -3dB points of 55MHz and 87MHz, and 1.6dB of insertion loss (Figure 8).

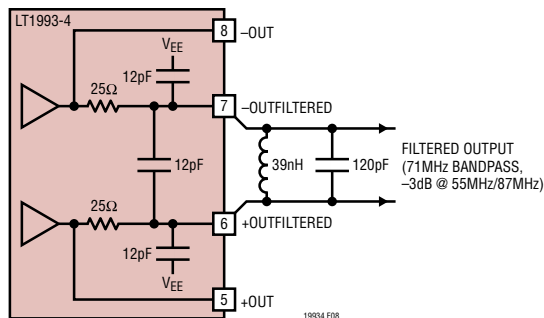

Figure 8. LT1993-4 Output Filter Topology Modified for Bandpass Filtering (1 External Inductor, 1 External Capacitor)

Output Common Mode Adjustment

The LT1993-4's output common mode voltage is set by the V_{OCM} pin. It is a high-impedance input, capable of setting the output common mode voltage anywhere in a range from 1.1V to 3.6V. Bandwidth of the V_{OCM} pin is typically 300MHz, so for applications where the V_{OCM} pin is tied to a DC bias voltage, a 0.1μF capacitor at this pin is recommended. For best distortion performance, the voltage at the V_{OCM} pin should be between 1.8V and 2.6V.

When interfacing with most ADCs, there is generally a V_{OCM} output pin that is at about half of the supply voltage of the ADC. For 5V ADCs such as the LTC17XX family, this V_{OCM} output pin should be connected directly (with the addition of a 0.1μF capacitor) to the input V_{OCM} pin of the LT1993-4. For 3V ADCs such as the LTC22XX families, the LT1993-4 will function properly using the 1.65V from the ADC's V_{CM} reference pin, but improved Spurious Free Dynamic Range (SFDR) and distortion performance can be achieved by level-shifting the LTC22XX's V_{CM} reference voltage up to at least 1.8V. This can be accomplished as shown in Figure 9 by using a resistor divider between the LTC22XX's V_{CM} output pin and V_{CC} and then bypassing the LT1993-4's V_{OCM} pin with a 0.1μF capacitor. For a common mode voltage above 1.9V, AC coupling capacitors are recommended between the LT1993-4 and the LTC22XX ADC because of the input voltage range constraints of the ADC.

APPLICATIONS INFORMATION

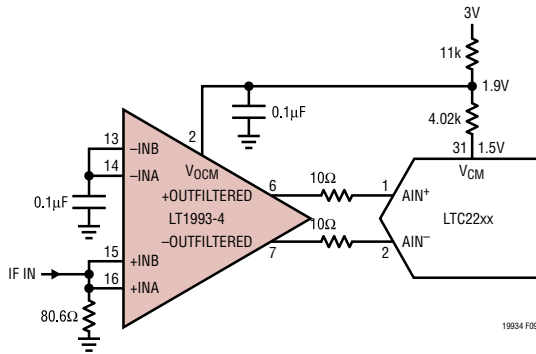

Figure 9. Level Shifting 3V ADC V_{CM} Voltage for Improved SFDR

Large Output Voltage Swings

The LT1993-4 has been designed to provide the $3.2V_{P-P}$ output swing needed by the LTC1748 family of 14-bit low-noise ADCs. This additional output swing improves system SNR by up to 4dB. Typical performance curves and AC specifications have been included for these applications.

Input Bias Voltage and Bias Current

The input pins of the LT1993-4 are internally biased to the voltage applied to the V_{OCM} pin. No external biasing resistors are needed, even for AC-coupled operation. The

input bias current is determined by the voltage difference between the input common mode voltage and the V_{OCM} pin (which sets the output common mode voltage). At both the positive and negative inputs, any voltage difference is imposed across 100Ω , generating an input bias current. For example, if the inputs are tied to 2.5V with the V_{OCM} pin at 2.2V, then a total input bias current of 3mA will flow into the LT1993-4's +INA and +INB pins. Furthermore, an additional input bias current totaling 3mA will flow into the -INA and -INB inputs.

Application (Demo) Boards

The DC800A Demo Board has been created for stand-alone evaluation of the LT1993-4 with either single-ended or differential input and output signals. As shown, it accepts a single-ended input and produces a single-ended output so that the LT1993-4 can be evaluated using standard laboratory test equipment. For more information on this Demo Board, please refer to the Demo Board section of this datasheet.

There are also additional demo boards available that combine the LT1993-4 with a variety of different Linear Technology ADCs. Please contact the factory for more information on these demo boards.

PACKAGE DESCRIPTION

UD Package 16-Lead Plastic QFN (3mm × 3mm) (Reference LTC DWG # 05-08-1691)

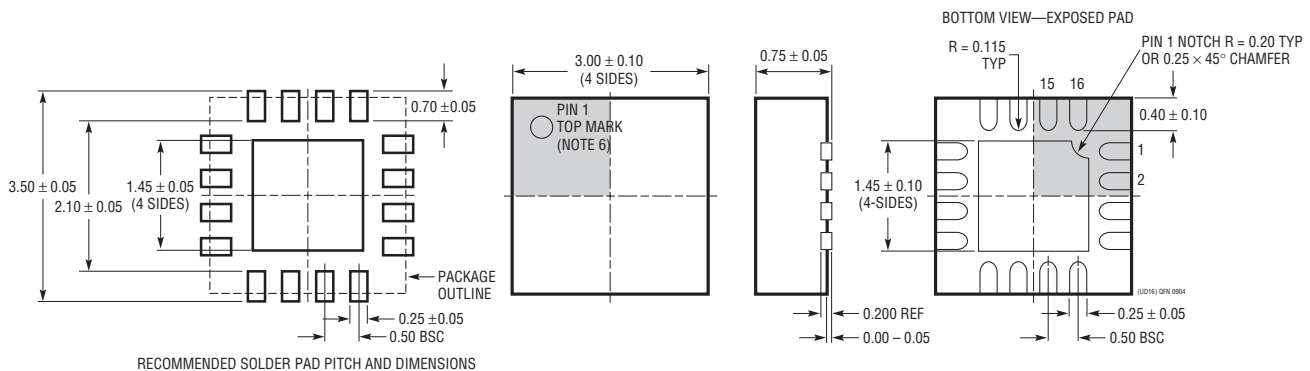

- NOTE:
1. DRAWING CONFORMS TO JEDEC PACKAGE OUTLINE MO-220 VARIATION (WEED-2)
 2. DRAWING NOT TO SCALE
 3. ALL DIMENSIONS ARE IN MILLIMETERS

4. DIMENSIONS OF EXPOSED PAD ON BOTTOM OF PACKAGE DO NOT INCLUDE MOLD FLASH. MOLD FLASH, IF PRESENT, SHALL NOT EXCEED 0.15mm ON ANY SIDE
5. EXPOSED PAD SHALL BE SOLDER PLATED
6. SHADED AREA IS ONLY A REFERENCE FOR PIN 1 LOCATION ON THE TOP AND BOTTOM OF PACKAGE

TYPICAL APPLICATION

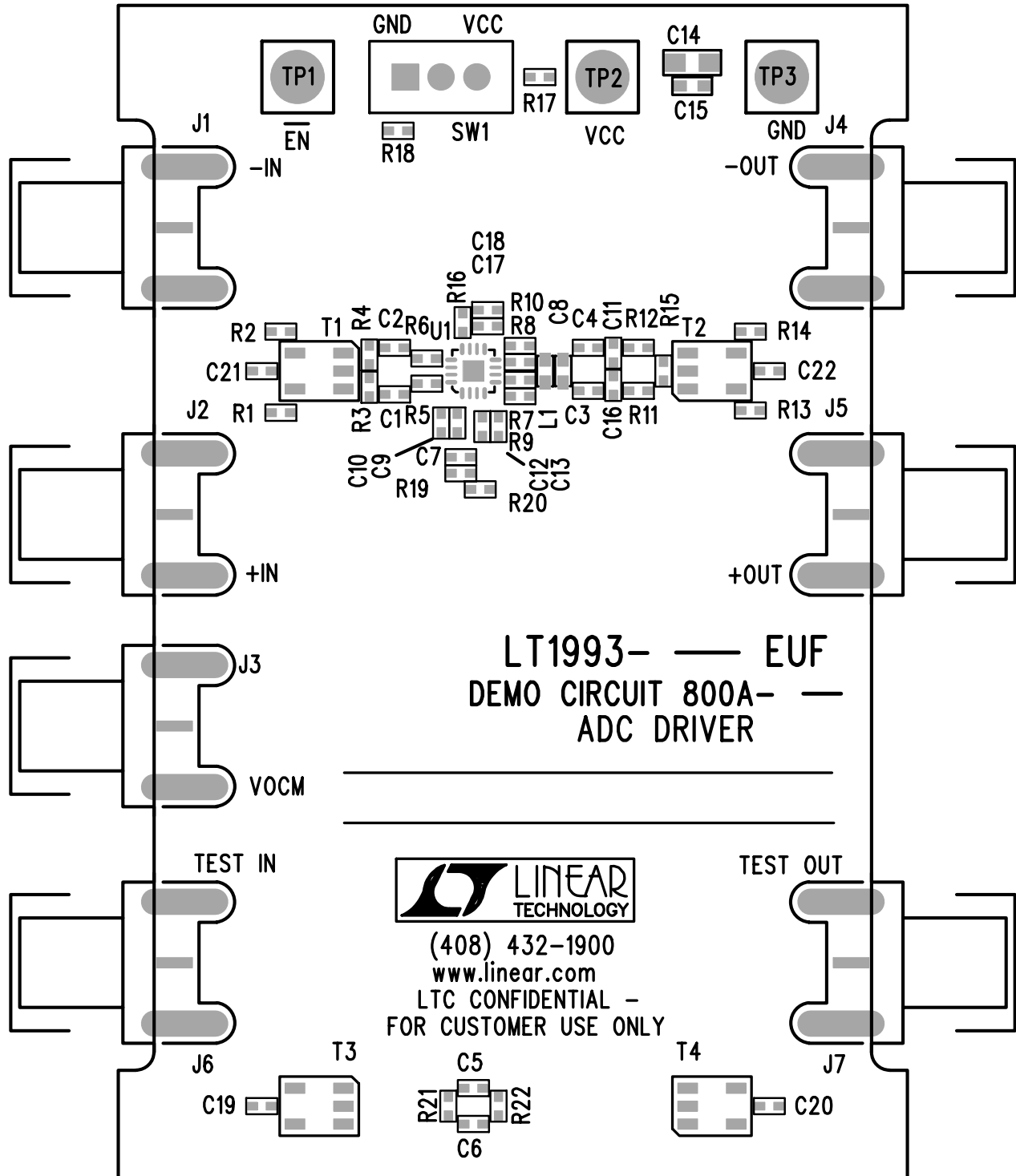

LINEAR TECHNOLOGY CORPORATION

TOP SILKSCREEN

800A REV 2
11/08/04

TYPICAL APPLICATION

Demo Circuit DC800A Schematic
(AC Test Circuit)

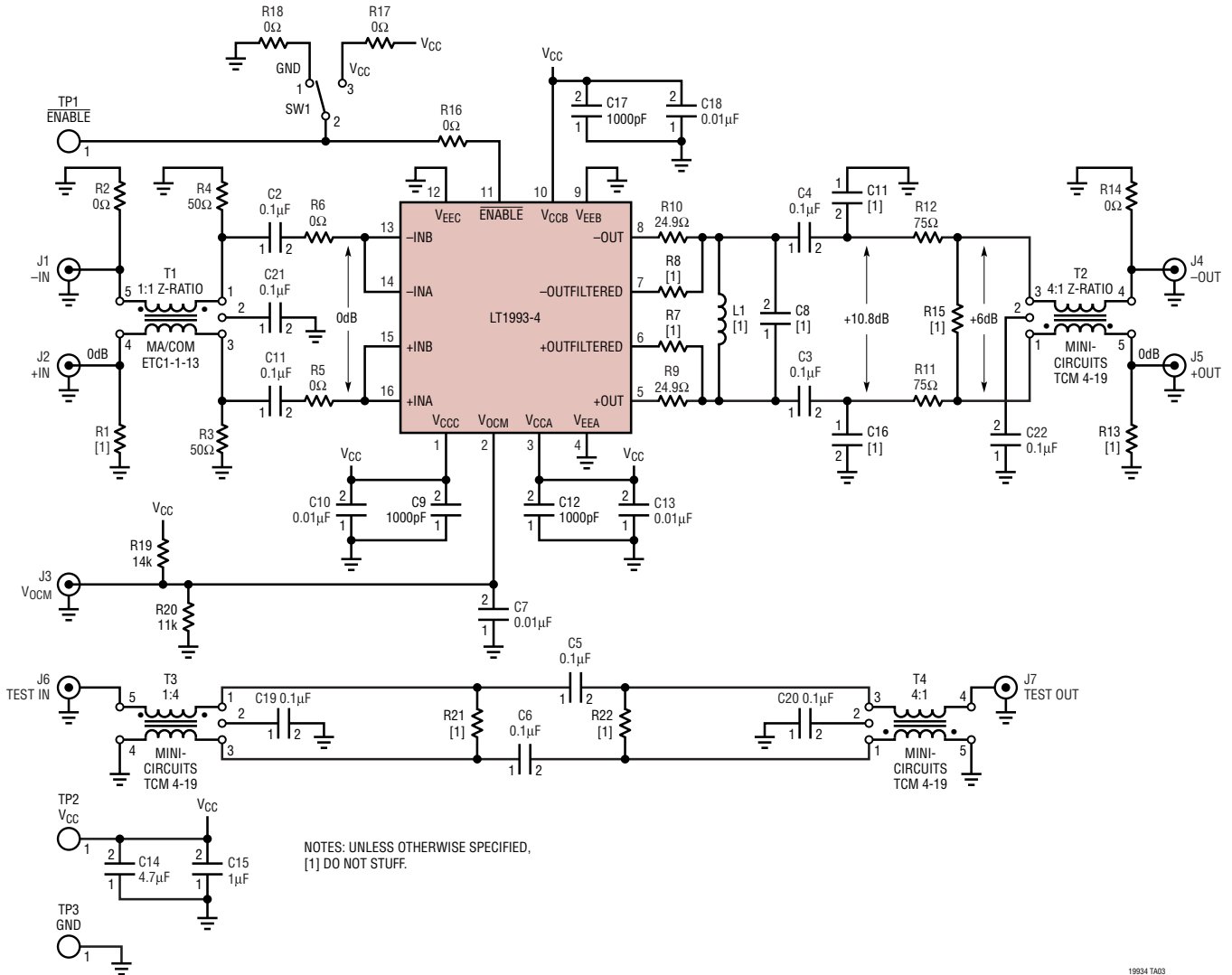

19934 TA03

RELATED PARTS

PART NUMBER	DESCRIPTION	COMMENTS
LT1993-2	800MHz Differential Amplifier/ADC Driver	$A_v = 2V/V$, $NF = 12.3dB$, $OIP3 = 38dBm$ at 70MHz
LT1993-10	700MHz Differential Amplifier/ADC Driver	$A_v = 10V/V$, $NF = 12.7dB$, $OIP3 = 40dBm$ at 70MHz
LT5514	Ultralow Distortion IF Amplifier/ADC Driver	Digitally Controlled Gain Output $IP3$ 47dBm at 100MHz
LT6600-2.5	Very Low Noise Differential Amplifier and 2.5MHz Lowpass Filter	86dB S/N with 3V Supply, SO-8 Package
LT6600-5	Very Low Noise Differential Amplifier and 5MHz Lowpass Filter	82dB S/N with 3V Supply, SO-8 Package
LT6600-10	Very Low Noise Differential Amplifier and 10MHz Lowpass Filter	82dB S/N with 3V Supply, SO-8 Package
LT6600-20	Very Low Noise Differential Amplifier and 20MHz Lowpass Filter	76dB S/N with 3V Supply, SO-8 Package

19934fa